



INTRODUCING THE NEXT WESTERN STAR



SIMPLY THE BEST TRUCK

WE'VE EVER BUILT.

WESTERN STAR TRUCKS have always been built to deliver more. More durability, more dependability and more value. And with the all-new 49X, we've taken that commitment even farther. This is a truck that breaks new ground both on the jobsite and in how the job gets done.

It breaks new ground in safety, in strength, in technology, in reliability and in what it means to build the world's toughest truck. It's a truck born from hard work, with a heritage of performing in a world of unforgiving conditions, just like the people who own them. That's why we believe you don't just buy a Western Star, you earn it. So, whether you've owned Western Star for years or never have before, it's time to own the next Western Star.

IT'S TIME TO BREAK NEW GROUND WITH THE ALL-NEW 49X.

➤ BUILT WITH ONE GOAL IN MIND

We spent half a decade designing and engineering the all-new 49X to be the best vocational truck on the market. Period. To achieve that, the 49X had to meet seven benchmarks we established at the start of the project. And we put it to the test to make sure it delivered on every one of them.



LEGENDARY DURABILITY



PURPOSE-BUILT



SUPERIOR OPERATOR COMFORT



PROVEN POWERTRAIN OPTIONS



BEST-IN-CLASS SAFETY



EASY UPFIT



MAXIMIZED UPTIME

TESTING



CAB INTEGRITY TEST



DURABILITY INSPECTION

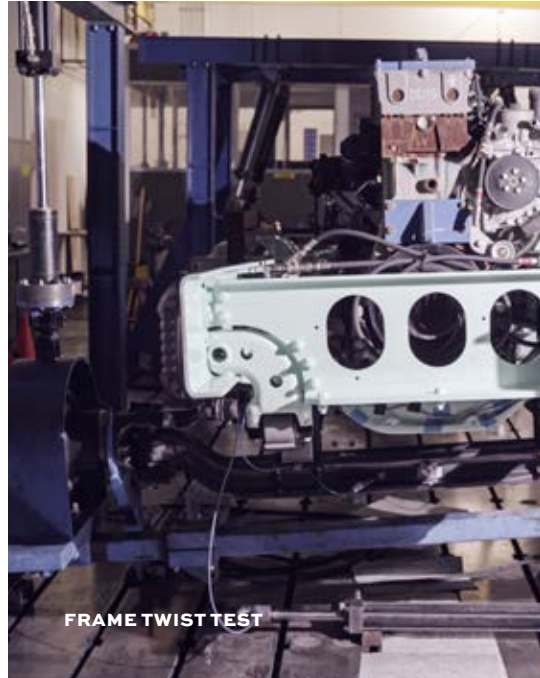

FRAME TWIST TEST



CAB CRUSH TEST



MADRAS FRAME TWIST DURABILITY TRACK



SHAKE TEST



MADRAS ROUGH ROAD TESTING TRACK



DOOR SLAM TEST



CAB SHAKER DURABILITY TEST



MADRAS DURABILITY TRACK



BEMIDJI WINTER TEST

PROVEN.

LIKE NO OTHER.

The Western Star 49X has been tested like no other Western Star before. Built from the ground up using an incredible selection of new features developed specifically to survive the challenges of the vocational market – as well as proven components with thousands of hours of real-world performance – and matched with cutting-edge technology to make that performance even better. Then we tested it – every nut, bolt and component to simulate 10 to 15 years of use. In the end, every feature of this truck exceeded our already demanding standards. Because it has to pass our tests before you can put it to yours.





LEGENDARY DURABILITY

All-new heavy-duty vocational chassis

ALWAYS BUILD

ON A STRONG FOUNDATION.

The 49X features an all-new heavy-duty vocational frame, engineered and built from the ground up to meet the demands of severe service applications while still being lighter weight, more durable, easier to service and extremely truck equipment manufacturer friendly. That means from the start you'll have a truck that can handle more payload and deliver greater uptime for improved profitability.

FRAME HEIGHTS

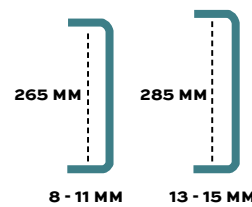

FRAME	RBM
8MM	1.8 INCH-LBS
9MM	2.0 INCH-LBS
11MM	2.5 INCH-LBS
13MM	3.2 INCH-LBS
15MM	3.7 INCH-LBS
13MM WITH 6MM REINFORCEMENT	4.5 INCH-LBS
15MM WITH 9MM REINFORCEMENT	5.6 INCH-LBS

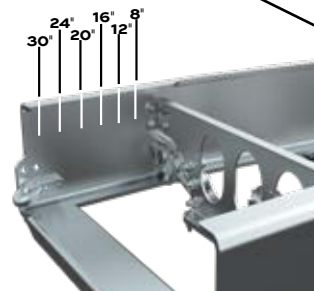

FULL PARENT FRONT FRAME RAIL EXTENSION OPTIONS

Multiple parent rail front frame extension options are available, eliminating the need for bolt-on extensions or reinforcements.



SPLAYED FRAME RAILS

Splayed frame shape at the front of the chassis allows for lower engine and radiator packaging that optimizes hood slope for increased visibility and safety, as well as improved engine serviceability.

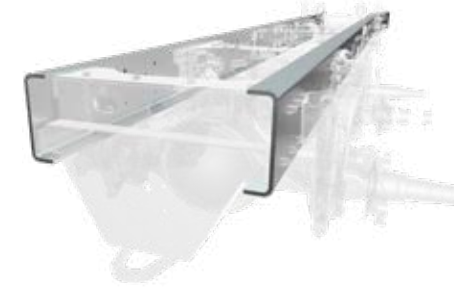

SINGLE-CHANNEL RAILS

The industry's first high-strength single-channel rail gets you an RBM of 3.7 million inch-lbs. All the strength you need without the weight and risk of corrosion.

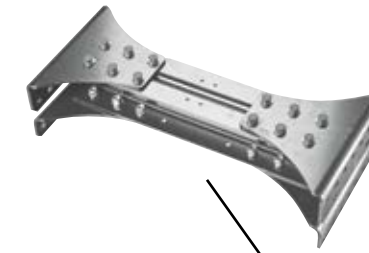

BOLTED CROSSMEMBERS

All midship and suspension crossmembers are bolted, not welded, for greater durability and easier maintenance.

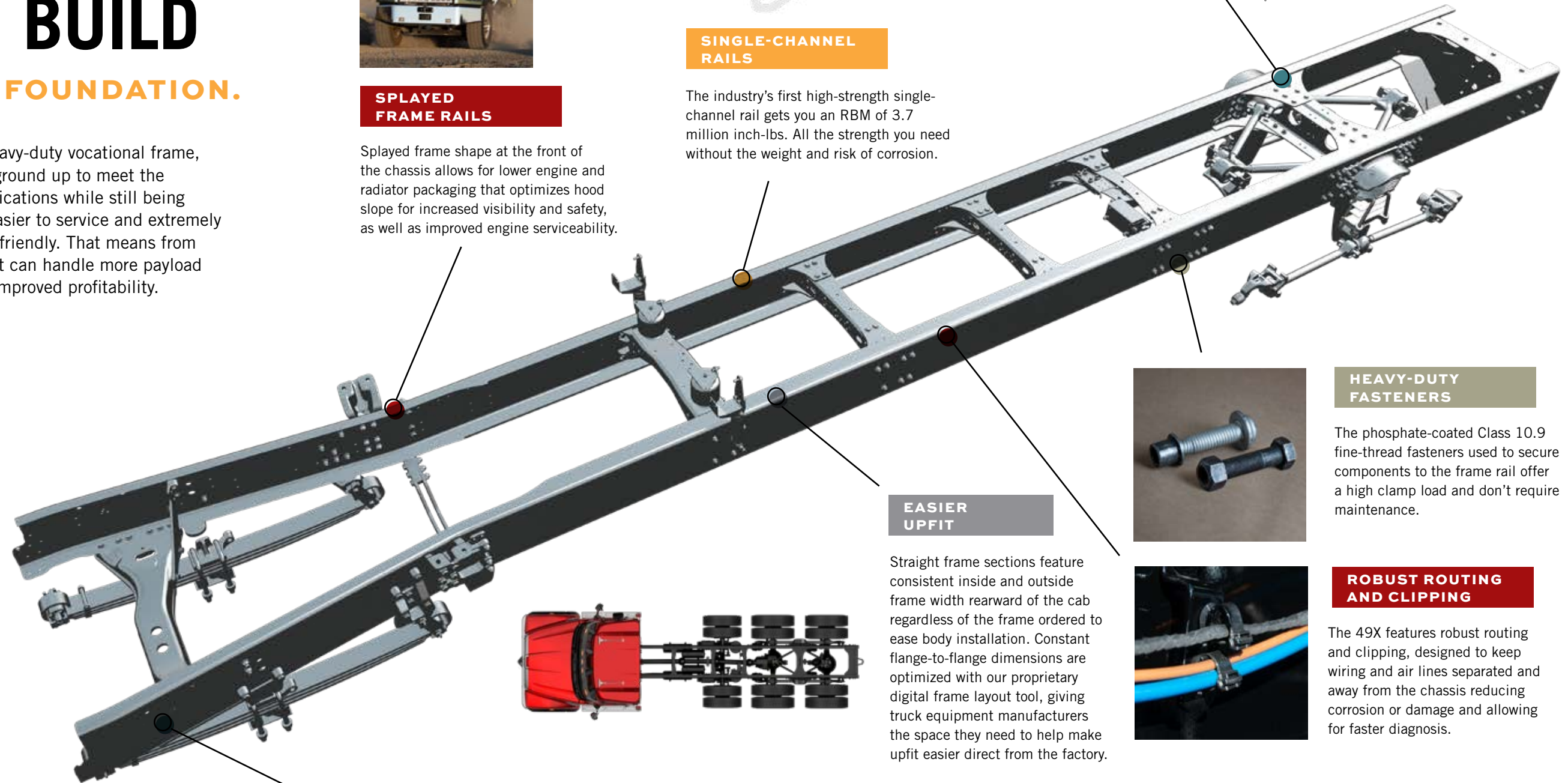

EASIER UPFIT

Straight frame sections feature consistent inside and outside frame width rearward of the cab regardless of the frame ordered to ease body installation. Constant flange-to-flange dimensions are optimized with our proprietary digital frame layout tool, giving truck equipment manufacturers the space they need to help make upfit easier direct from the factory.



HEAVY-DUTY FASTENERS

The phosphate-coated Class 10.9 fine-thread fasteners used to secure components to the frame rail offer a high clamp load and don't require maintenance.

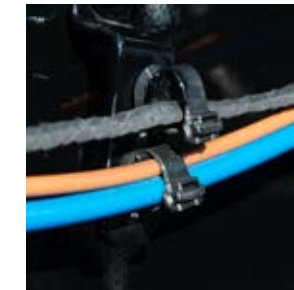

ROBUST ROUTING AND CLIPPING

The 49X features robust routing and clipping, designed to keep wiring and air lines separated and away from the chassis reducing corrosion or damage and allowing for faster diagnosis.

FRONT TOW ASSEMBLY OPTIONS

A number of towing device options are available to give you the purpose-built truck you need. They are all mounted directly to the front frame head for incredible strength, allowing you to pull your truck free without damage, even when using a bulldozer – with up to 140,000 lb tow capacity for extreme-duty applications like logging, when you have to be pulled out of the mud with a full load.





LEGENDARY DURABILITY

Lightweight, steel-reinforced cab

THE EVOLUTION OF TOUGH.

THE X-SERIES CAB.

Western Star has always set the standard for building some of the toughest and safest cabs around. We continue that tradition with our new X-Series vocational cab. The X-Series cab is engineered to handle the toughest jobs in the most unforgiving environments. Constructed from an aerospace-grade aluminum and enhanced with steel reinforcements, this new cab is lighter, safer, stronger and more spacious than any Western Star cab before. All of which adds up to a cab that is designed to protect and retain operators while delivering greater payload and uptime.



THE X-SERIES DOOR

Designed as an integral part of the steel-reinforced aluminum cab structure, the new X-Series door is crafted from rugged steel using state-of-the-art tooling to ensure unmatched fit and finish, then galvanized and hem sealed for complete corrosion resistance. The door is integrated with the cab utilizing forged steel hinges, which were slam tested to simulate 10 to 15 years of use so you know it will survive even your toughest days on the toughest jobsites.



STRUCTURAL OPTIMIZATION

Our engineers used state-of-the-art topology reinforcement technology to place structural material and reinforcements strategically to minimize weight while maximizing toughness and safety.

- > Backwall Header Reinforcement
- > Increased A-Pillar Section Size and Strength
- > B-Pillar Reinforcement
- > Hinge Reinforcements



TRENCH-STYLE LOW ROOF

Composite roof with a lowered center section enables optimized packaging of overcab equipment, giving you a purpose-built vehicle that minimizes overall vehicle height while maximizing interior headroom and door openings.



VOCATIONAL TUNED SUSPENSION

Based on millions of hours of real-world performance, our front and rear cab mounts reduce operator fatigue by providing optimal cab stability, helping deliver the incredibly comfortable ride Western Star is known for.

ENGINE TUNNEL

Quiet Steel®* engine tunnel reduces engine noise intrusion into the cab to provide a premium operating environment.

*Quiet Steel is a registered trademark of Material Sciences Corporation



LEGENDARY DURABILITY

Tough by design exterior

ALL METAL BRIGHTWORK

- Intake covers
- Grille
- Grille surround
- Sun visor
- Bumper

DUAL STAINLESS STEEL AIR INTAKES

EASY-ACCESS, GLOVE-FRIENDLY HOOD LATCHES

HOOD REINFORCEMENTS FOR AUXILIARY MIRRORS

DOUBLE-LAYERED, IMPACT-RESISTANT FENDERS

STAINLESS STEEL RADIATOR-MOUNTED GRILLE

ROBUST, SERVICEABLE ALUMINUM RADIATOR AND COOLING

STRUT ASSISTED HOOD OPENING AND CLOSING WITH STANDARD SAFETY LOCK

STRONGER. LIGHTER.

BETTER. THAN EVER.

The new hood on the 49X was engineered to improve durability and performance, as well as provide your operators best-in-class visibility. This new hood is incredibly strong, thanks to our new molded resin material that's robotically sealed and bonded together for precision-manufactured quality and durability. It's nearly 100 pounds lighter than our previous hood and is designed to resist high impacts to last the life of the vehicle.

HOOD OPENING ASSIST STRUT

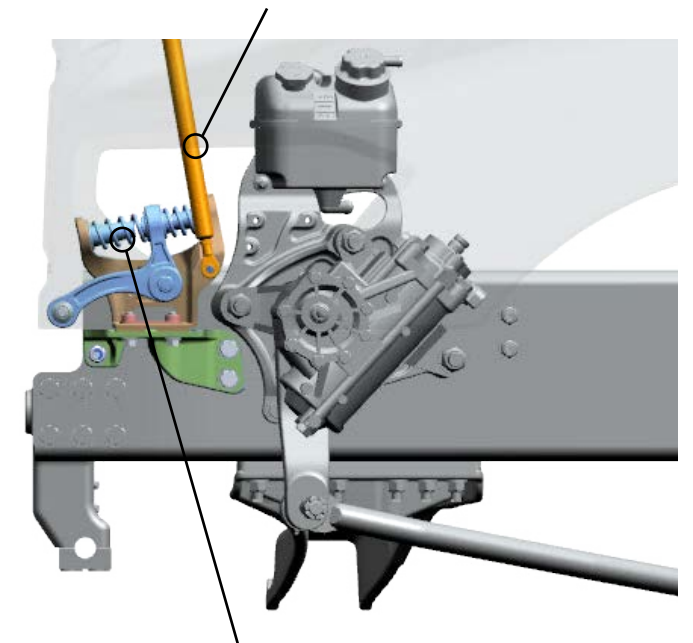

ROBUST ISO TECH HOOD SUSPENSION SYSTEM

The all-new Western Star-exclusive ISO Tech Hood Suspension System is purpose-built to isolate the hood from even the most brutal road conditions.



SUPERIOR OPERATOR COMFORT

An interior that's far from ordinary

RISE ABOVE THE EVERYDAY.

DASH

The interior of the all-new 49X features all the comforts that not only let it stand above the rest, it helps make long days a little bit easier. The spaciousness creates an inviting environment, while the insulation, fit and finish improves both sound levels and temperature control. And the ergonomic design puts control and critical information within reach, making even the toughest jobs more manageable. It's the kind of comfort that keeps your operators alert and helps keep your business profitable.



SUPERIOR OPERATOR COMFORT

Spacious, rugged interior

STAY IN COMPLETE CONTROL.

The dash of new 49X is designed to let operators keep their hands on the wheel and eyes on the road. In addition to easy-to-read gauges, this new instrument cluster features our Driver Command Center, which provides a wealth of information such as gear selection, and gauge readings like oil pressure, as well as fault events and feedback from the Detroit Assurance® suite of safety systems.

The ergonomic wraparound dash not only makes the operator's job easier, it provides a modern look that allows up to 13 additional gauges on the dash in addition to the six digital gauges available in the Driver Command Center. Combined with our new integrated steering wheel controls, the 49X not only helps keep operators alert, it helps keep their eyes and hands right where they need to be.



CONTROLS

Remote mirror and window control switches are within easy reach, located on the door panels for convenience.

MULTI-FUNCTION STEERING WHEEL

The 49X steering wheel features integrated controls for cruise control, Bluetooth phone, and Driver Command Center interaction, allowing operators to safely keep their focus on the job and the road ahead.

FLEXPANEL

Proprietary FlexPanel provides the space and flexibility to easily integrate ELD or other telematics tablets, up to 24 switches or up to 10 gauges.

QUICKFIT DASH ACCESS

Located on top of the dash near the windshield to easily route wires to power dash-mounted devices.



HVAC

The new 49X HVAC system is designed to deliver best-in-class performance, reliability and serviceability with five face outlets, four floor outlets and two side window defrost outlets, as well as 10 blower speeds for optimal performance and operator/passenger comfort.



STEERING COLUMN

Fully adjustable to provide a full range of motion for increased operator comfort.



CUPHOLDERS

Three extra-large cupholders are within convenient reach of the operator and designed to hold even the largest beverages.



VOCATIONAL SWITCHES

Rocker-style dash switches are large enough to operate with gloves on, are easy to read with laser-etched graphics and backlighting, and make programming outputs/interlocks easier and upfit faster than ever thanks to our proprietary CHEC Tool.



TRANSMISSION CONTROL STALK

For automated manual and automatic transmission shifting and engine braking functions for safer operation.



PTO CONTROL LOGIC

When the PTO is engaged, you can view your engine speed presets in the Driver Command Center and, using the control buttons in the multi-function steering wheel, change engine speeds with the push of a button.



SUPERIOR OPERATOR COMFORT

Extensive interior options

DESIGN AS INCREDIBLE

AS OUR ENGINEERING.

Western Star trucks have always been known for operator comfort and the 49X takes it to another level. Our Base Interior Package includes a selection of durable materials and ergonomic features to deliver long-lasting beauty and comfort that makes working behind the wheel productive and enjoyable.

Upgrading your 49X to the Premium Interior Package takes that operator comfort and productivity to even greater heights. The Premium package includes features that make long days a little easier like Laredo leather seat and sleeper upholstery, premium insulation for greater quiet and temperature control, premium LED cab lighting for reduced eye strain, along with accents like bright finish steering wheel switches and dash gauge bezels, premium teak trim accents and more that let operators know they're working with a truck that's far beyond ordinary.

INTERIOR COLOR

X-Series Base



Quarry Grey Charcoal Black

INTERIOR COLOR

X-Series Premium



Quarry Grey Charcoal Black Timber Brown

SEATS

X-Series Base



Charcoal Black Quarry Grey

SEATS

X-Series Premium



Charcoal Black Quarry Grey Timber Brown

Available in Mordura cloth (inset) or Laredo Leather and diamond stitching (shown large).



X-SERIES BASE



X-SERIES PREMIUM





PROVEN POWERTRAIN OPTIONS

Components with a long history of performance.



THE POWER

TO GET ANY JOB DONE.

PROFESSIONAL QUALITY WORK TRUCK POWERTRAIN COMPONENTS FROM DETROIT

Give your 49X added toughness and dependability with enhanced Detroit vocational engine options, new Detroit vocational transmissions and axles, all designed to work seamlessly together for unmatched performance on the job site.

- > The Detroit® DD15® Gen 5, the latest achievement in industry-leading power and performance from Detroit. This versatile engine was designed with vocational-specific features including new power ratings and improved aftertreatment system to decrease regens
- > Detroit® DD16®, the industry's only 16-liter engine, delivers up to 600 HP and 2,050 lb-ft for demanding applications
- > New Detroit® DT12®-V and DT12®-VX vocational automated manual transmissions
- > Rugged and dependable Detroit® drive and steer axles



DETROIT® DT12® VOCATIONAL SERIES

The new DT12 Vocational Series of automated manual transmissions has been specially engineered and rigorously tested for the unique needs of vocational trucks. Legendary Detroit quality is combined with cutting-edge technology and durable new components like large, robust gearing for even greater dependability. And you'll find this rugged performance in two new models – the DT12-V and DT12-VX – that boast new vocational features including:

- > Rock-Free Mode allows the 49X to free itself from wheel stuck situations
- > Off-Road Mode enables smooth driving on extreme terrain
- > Power Launch provides powerful takeoffs while protecting the clutch and driveline



ROCK-FREE MODE

ENGINES



DETROIT® DD15® GEN 5

- > **HORSEPOWER**
Up to 505HP
- > **TORQUE**
Up to 1,850 lb-ft.



CUMMINS X12

- > **HORSEPOWER**
Up to 500HP
- > **TORQUE**
Up to 1,700 lb-ft.



DETROIT® DD16®

- > **HORSEPOWER**
Up to 600HP
- > **TORQUE**
Up to 2,050 lb-ft.



CUMMINS X15

- > **HORSEPOWER**
Up to 605HP
- > **TORQUE**
Up to 2,050 lb-ft.

TRANSMISSIONS

To spec the exact transmission you need, see your nearest Western Star dealer.

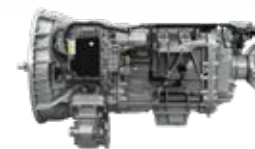

DT12-V

Automated Manual Vocational Transmission

TORQUE
2,250 lb-ft.

GCW
160,000lbs.

REAR PTO
Yes

SIDE PTO
Yes



DT12-VX

Automated Manual Vocational Extreme Transmission

TORQUE
2,500 lb-ft.

GCW
330,000lbs.*

REAR PTO
Yes

SIDE PTO
Yes

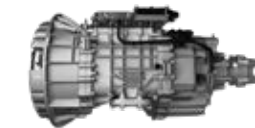

EATON FULLER

Manual and Automated Manual Transmissions

TORQUE
1,650-2,250 lb-ft.

GCW
170,000lbs.**

REAR PTO
Yes

SIDE PTO
Yes



ALLISON

Automatic Transmissions

TORQUE
1,650-1,850 lb-ft.

GCW
170,000lbs.**

REAR PTO
Yes

SIDE PTO
Yes

*Application approval required over 160,000lbs. **Application approval required over 170,000lbs.

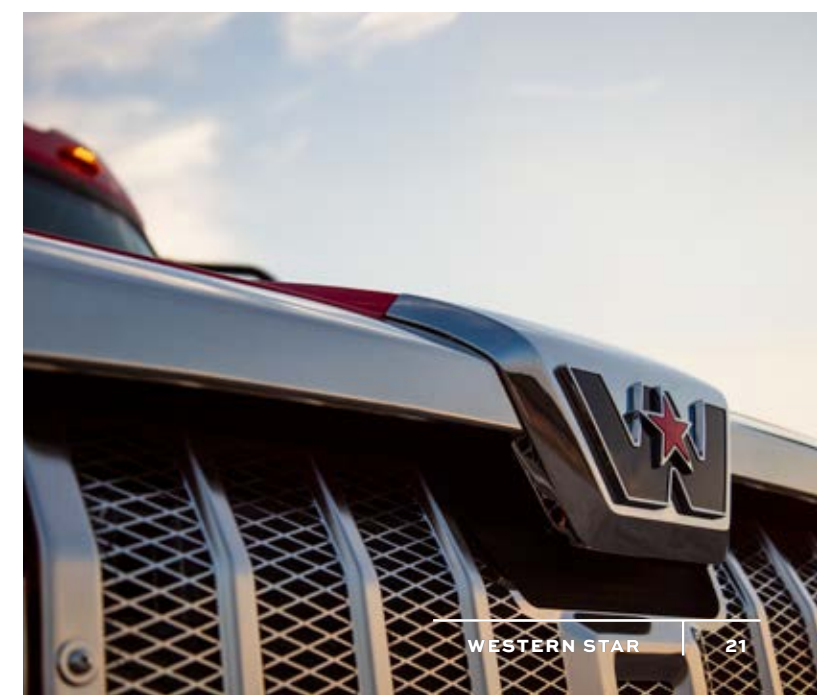



BEST-IN-CLASS SAFETY

The leading-edge technology of Detroit Assurance

THE MOST ADVANCED SAFETY SYSTEMS

EVER SEEN IN THE VOCATIONAL MARKET.

Technology gets tough in the all-new 49X, the first Western Star to feature the Detroit Assurance® Suite of Safety Systems, the most advanced active safety systems ever offered to the vocational market. From remote logging sites to urban construction sites, Assurance improves safety there and back.

FEATURES OF DETROIT ASSURANCE

ACTIVE BRAKE ASSIST 5

Active Brake Assist 5 detects distance and speed to moving and stationary objects in its path and determines if braking is necessary. It's the only system on the market that works down to 5 MPH, making it ideal for travel in congested urban areas. It also recognizes pedestrians who are about to cross in the truck's path, alerting the operator while partially braking, followed by full braking if the operator does not react. The market leading ABA 5 has fused a camera and radar which is cutting-edge technology.



SIDE GUARD ASSIST

A game changer for safety in and around busy jobsites, optional Side Guard Assist detects objects in the passenger side blind spot and alerts the operator.



ADAPTIVE CRUISE CONTROL TO 0 MPH AND TAILGATE WARNING

Detroit Assurance technology enables state-of-the-art features such as Adaptive Cruise Control to 0 MPH and Tailgate Warning to ease driving in stop and go traffic, as well as help mitigate front and rear collisions as operators travel from one jobsite to the next.

- > **LANE DEPARTURE WARNING**
- > **AUTOMATIC HEADLIGHTS/WIPERS**
- > **INTELLIGENT HIGH-BEAMS**
- > **FORWARD- AND OPERATOR-FACING VIDEO CAPTURE**





BEST-IN-CLASS SAFETY

Safe by design

VISIBLY DIFFERENT.

UNQUESTIONABLY SAFE.



THE 49X WINDSHIELD

The new 49X features an all-new, one-piece, roped-in windshield, which is 28% larger than our previous version, making it one of the largest windshields in its class. Other features include:

- 24-inch wiper blades that cross over the center of the glass, providing a 37% improved windshield wiper zone
- Optional impact-resistant windshield glass to protect from rocks or other debris
- Heated windshield option delivers heat throughout the windshield, which speeds up defrost in icy/snowy conditions, as well as prevents refreeze and the freezing up of the wipers for improved visibility
- One-piece, roped-in windshield is easy to replace and needs no curing to replace, increasing uptime



BEST-IN-CLASS SAFETY

Safe by design

SAFETY

THAT IS EASY TO SEE.

INTELLIGENT LED HEADLIGHTS

Dual Stage Intelligent LED Headlights are designed to last the lifetime of the truck, with no bulbs to replace ever. Plus, they deliver best-in-class visibility and improved safety with:

- Integrated amber daytime running lights to make the truck more visible to oncoming traffic and on the jobsite
- LED output is designed to fully illuminate the road and jobsite, including off to the sides of the vehicle, to reduce eye fatigue while letting operators detect objects sooner
- Dual-stage heat grid melts away ice in minutes and, in humid environments, eliminates condensation,
- High-impact polycarbonate lenses with additional hard coating protection to prevent cracking, scratching or damage to the headlight from road or jobsite debris

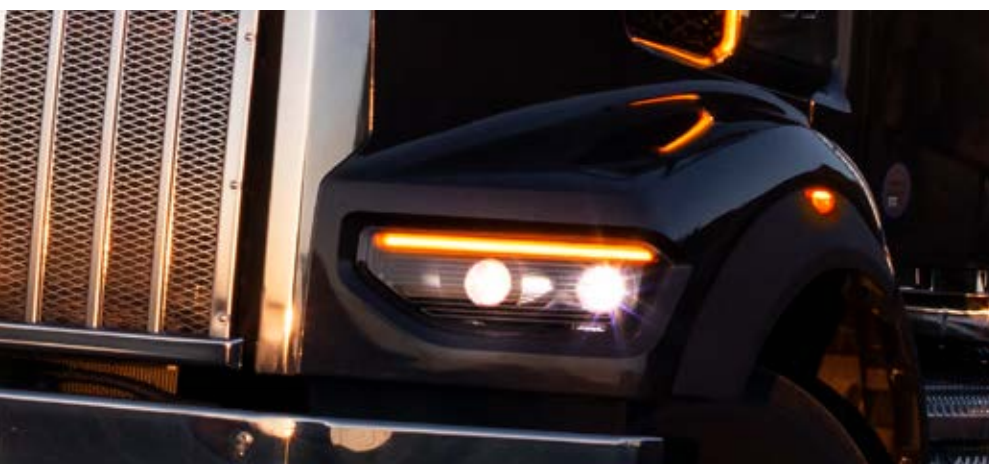

REAR WINDOW OPTIONS

Rear visibility is also maximized on the 49X. A large single center rear window is standard with day cabs while our new optional high-visibility three-window configuration increases the rear window area by 77% over our previous models. Optional impact-resistant polycarbonate rear window configurations are available, protecting your truck from road or jobsite debris.

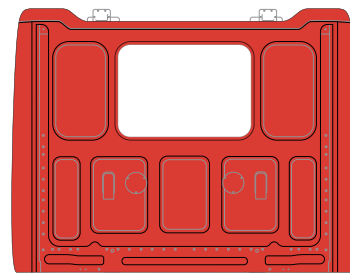

Standard Single Rear Window

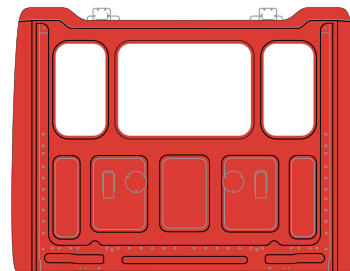

Optional Three-Piece Rear Window

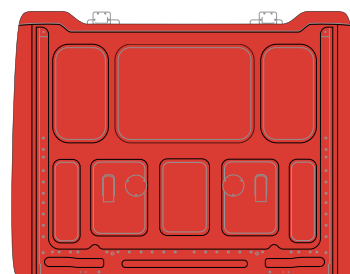

Optional Solid Wall

INGRESS AND EGRESS

Western Star designed the 49X with operator safety in mind, which includes getting in and out of the cab. Some of the features to improve ingress and egress safety include:

- Strategically located grab points and grab handles for safe and comfortable entry and exit
- Metal scuff plates that define the entry and make the cab easy to sweep out, keeping it debris-free
- Highly-visible corrosion-resistant aluminum steps are one inch larger than previous models
- Enhanced tread pattern allows debris to pass through, giving operators a confident foothold when climbing in and out of the truck
- Improved stair step design to provide operators a confident foothold



STRONG AND STABLE.

FUNCTION THAT'S INCREDIBLY TOUGH.



THE C-BAR MIRROR SYSTEM

Visibility is critical, which is why the all-new C-Bar door mounted mirror arms feature a reduced profile for greater forward visibility for when operators need to see around them. The tuned door and mirror structure was designed to avoid mirror vibration and deliver a stable image at all times, regardless of vehicle speed or road surface, while also allowing for a wide 70-degree door open angle. Plus, this reinforced construction, combined with our breakaway feature, means these mirrors can take a hit and not get damaged. All of which means these mirrors improve safety and your bottom line.



DESIGNED FOR UPFIT

Truck Equipment Manufacturer (TEM) Friendly



BUILT TO BE BODIED UP.

ENGINEERED FOR UPFIT.

The 49X was designed and engineered with a variety of mid-chassis packaging options, a brand new electrical system and numerous features all to ease body upfit and make accessing wiring and adding controls fast and simple.

QUICKFIT INTERFACE SYSTEM

The electrical system is the hub of any body addition. Our proprietary QuickFit Interface System makes it easier than ever before to integrate truck equipment to the vehicle's electrical power sources. It features an advanced multiplexed electrical system designed for easy Truck Equipment Manufacturer (TEM) interface, programming and access to power.

- > All electronic control units are now stored in the cab in the new dash electronic vault or E-Vault for easy access
- > Key components are protected from the elements and accessed without having to use tools
- > An auxiliary in-cab backwall mounted E-Vault is also available and includes:
 - QuickFit Programmable Controllers
 - QuickFit Connectors
 - Customer Interface Connectors
 - Powertrain Interface Connector
 - Body Lighting Interface Connectors (also available back-of-cab or end-of-frame)
 - TEM-specific power distribution module
 - High-current power access
- > Additional exterior lighting interface available for snow plow, beacon, and utility lights
- > Our all new PTO control architecture is designed to simplify complex PTO control logic programming. The sky is the limit for all your logic programming needs, as simple or complex as you want

MID-CHASSIS PACKAGING

The 49X chassis was designed to make it easier than ever to mount bodies for any application.

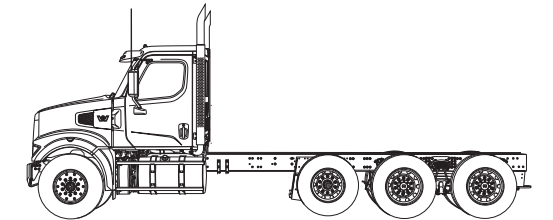

The mid-chassis packaging offered includes features that deliver clear back-of-cab to ensure more efficient body integration. Key mid-chassis packaging features include:

- > Forward-mounted DEF tanks in 8-, 13-, and 23-gallon capacities
- > Standard in-cab battery box to optimize frame space. Between rails or frame-mounted boxes also available
- > Variety of air tank mounting options available including below battery box, inside or below frame rail, or perpendicular to the frame
- > 25-inch diameter fuel tanks are available from 60 to 150 gallons and can be mounted either side, forward or aft
- > Factory-installed split hydraulic/fuel tanks available to save upfit time and maximize frame space
- > Updated standard air dryer mounting location clears up frame space behind the cab

ALL 49X TECHNICAL DETAILS CAN BE FOUND IN THE TECHNICAL RESOURCE GUIDE (TRG). FOR ACCESS TO THE TRG, LOG ON TO DTNACONNECT.COM.



CHEC TOOL

Western Star's proprietary CHEC Tool is the interface to the 49X's programmable controllers. It enables TEMs and dealers to view and modify electrical configurations on the 49X, giving them the power to customize inputs and outputs and change parameters within minutes, drastically reducing upfit time.



PURPOSE-BUILT

Customizable factory options

BUILT FOR ONE JOB.

YOURS.

The 49X is purpose built, with hundreds of options to help you build exactly the truck you need.



Dual Removable Tow Hoops – 80,000 lbs



Center Tow Pin – 80,000 lbs



High Capacity Center Tow Pin – 140,000 lbs

PTOS

The wide selection of engines and transmissions means you can spec front and rear engine PTOs (FEPTO AND REPTO) and transmission-mounted PTOs, which allows you to install the equipment you need on your 49X.

AIR CLEANER OPTIONS

The optional pre-cleaner removes 80% of the particles out of the air before entering the primary air cleaner, extending filter life and service intervals in off-road environments. Optional snow doors are available to pull intake air from underhood when conditions may cause side air intakes to plug with snow or ice.

TOOL BOXES

Locking tool boxes are offered in 18-, 24-, and 34-inch widths. They're constructed from durable, lightweight aluminum and can be ordered with plain, polished or diamond plate finish covers.

BUMPERS

The 49X offers three bumper styles in various finishes and thicknesses, as well as a boxed-in bumper with an optional grille guard for logging applications. All 49X bumpers are tapered at the wheel ends for ground clearance and weight savings.

FRONT TOW DEVICES

There are a number of towing device options mounted directly to the front frame head for increased strength and durability with ratings from 80,000-140,000 lbs.



TANKS

FUEL TANKS

25" Diameter, 60-150 gallons
Side, fore or aft mounted
Fuel/hydraulic combo tanks also offered

DEF TANKS

8-, 13-, and 23-gallons
Mounted in the most forward position, regardless of size.

EXHAUST OPTIONS

Single right-hand cab-mounted vertical exhaust (standard)
Single right-hand mid-chassis-mounted horizontal exhaust
Dual cab-mounted vertical exhaust
Dual frame-mounted vertical exhaust
Back of cab, frame-mounted vertical ATS with topstack

AXLES CONFIGURATIONS

STEER AXLES

Detroit® and Meritor – 12,000-23,000 lbs

REAR DRIVE AXLES

Detroit®, Meritor and Dana
Single – 21,000-30,000 lbs
Tandem – 40,000-60,000 lbs
Tridem – 69,000-78,000 lbs

PUSHER AND TAG AXLES

Steer and Non-Steer – 8,000-25,000 lbs

REAR SUSPENSIONS

AirLiner, TufTrac, Chalmers, Hendrickson and Neway are available.

Single – 21,000-30,000 lbs
Tandem – 40,000-70,000 lbs
Tridem – 69,000-78,000 lbs



SUPERIOR OPERATOR COMFORT

Multiple sleeper options

KEEP OPERATORS COMFORTABLE

AND KEEP THEM ON YOUR TEAM.

Operator retention is important for any business, and the new sleeper options on the 49X are designed to keep them both comfortable and happy. From our new trench-style Low Roof to our Stratosphere High Roof, every sleeper on the 49X gives operators the space, the features and the amenities that allow them to relax and recharge.



X-SERIES SLEEPER

**TRENCH-STYLE
LOW ROOF SLEEPER***

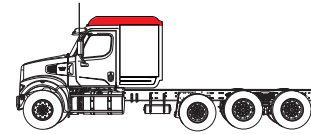

Available in 36"

MID ROOF SLEEPER

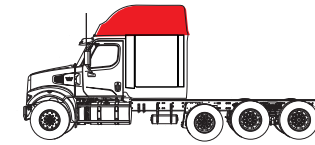

Available in 36", 48", 60" and 72"

**STRATOSPHERE
HIGH ROOF SLEEPER**

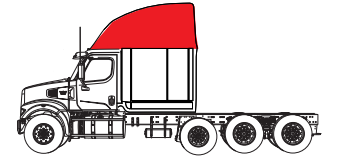

Available in 72"



36" Low Roof

48" Mid Roof

60" Mid Roof

72" Stratosphere High Roof

*Available late 2021



SUPERIOR OPERATOR COMFORT

Sleeper features and systems

DESIGNED FOR GREATER COMFORT

AND PRODUCTIVITY.

In the new 49X sleepers, there are a number of features and options that give operators the living and working space they need when they're on the road to help them rest so they're alert and engaged behind the wheel. Depending on the configuration you choose, some of the amenities include:

- > A comfortable double-bunk option with space-saving telescoping ladder
- > Large sidewall sleeper window is insulated for comfort and can be tilted out for venting
- > LED Premium Ambient Overhead Sleeper Lighting with dimmer on 72-inch models provides indirect illumination that makes activities like reading, updating logs or computer work easier
- > Optional operator's loft with dinette/work table that can be folded flat to allow a full bed mattress comfort
- > Both side access and baggage doors added for easier access and greater storage
- > Reading light to make sleeper tasks easier while saving battery life
- > Bunk storage lip to reduce likelihood of storage items moving while driving
- > Large passenger-and operator-side storage cabinets
- > Spacious wardrobe cabinet with four inches of additional hanging length
- > Conveniently located microwave cabinet built to accommodate standard appliances
- > Large refrigerator with matching cabinetry or the option to supply your own refrigerator
- > Swiveling flat-panel TV bracket that can support up to a 26-inch screen
- > Multiple DC power outlets
- > A variety of powerful inverter and inverter pre-wire options for AC-powered items
- > Enhanced HVAC for better climate control in bunk area
- > New Idle-Free Dual HVAC system that provides up to 10 hours of cooling or 34 hours of heating when parked
- > Severe Weather Package option for added comfort in demanding conditions
- > New rear window option



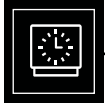

MAXIMIZED UPTIME

Extensive parts and service support

TOUGH TRUCKS.

BACKED BY EVEN STRONGER SUPPORT.

Your trucks are a big investment. That's why we make sure you have the factory support you need to succeed.

24-HOUR REPAIR

We work to deliver 24-hour repair turnaround with 1,100 Daimler Trucks North America dealer network and partner service locations to assist you, including more than 300 Elite Support locations that handle over 80% of our parts and service volume.

PARTS AVAILABILITY

Western Star is your one-stop solution for parts and service. In addition to our service locations, we have 10 Parts Distribution Centers across North America that carry a wide selection of Western Star, Reman and Alliance parts. And with an average delivery time of 12 hours or less on more than 90% of parts orders, your truck will be back on the road fast.

ADVANCED TECHNOLOGY

We invest in technology that can keep your trucks working and working longer. And that goes well beyond technology like Detroit Connect®. With Western Star, you get a full suite of uptime management services and technology to get your trucks back working as soon as possible.

At your dealer, you'll experience applications like Uptime Pro, Express WriteUp, Techlane™ and Service Tracker which work together to get you checked in for service quickly, diagnosed quickly and back on the job quickly. And if you perform regular maintenance yourself, ExceleratorSM is our new e-commerce platform that lets you search, find and buy all in one place for ease of use and reduced downtime. At Western Star, even our technology works hard.

YOU'RE COVERED

Strong support also means having a strong warranty. And Western Star trucks are backed by one of the strongest standard warranties in the business.

Extended coverage plans for our truck chassis are designed to reduce downtime and costly repairs by extending protection for time and mileage above and beyond the factory warranty period. Multiple plans are available for up to seven years/250k miles for vocational applications or six years/600k miles for on-highway.

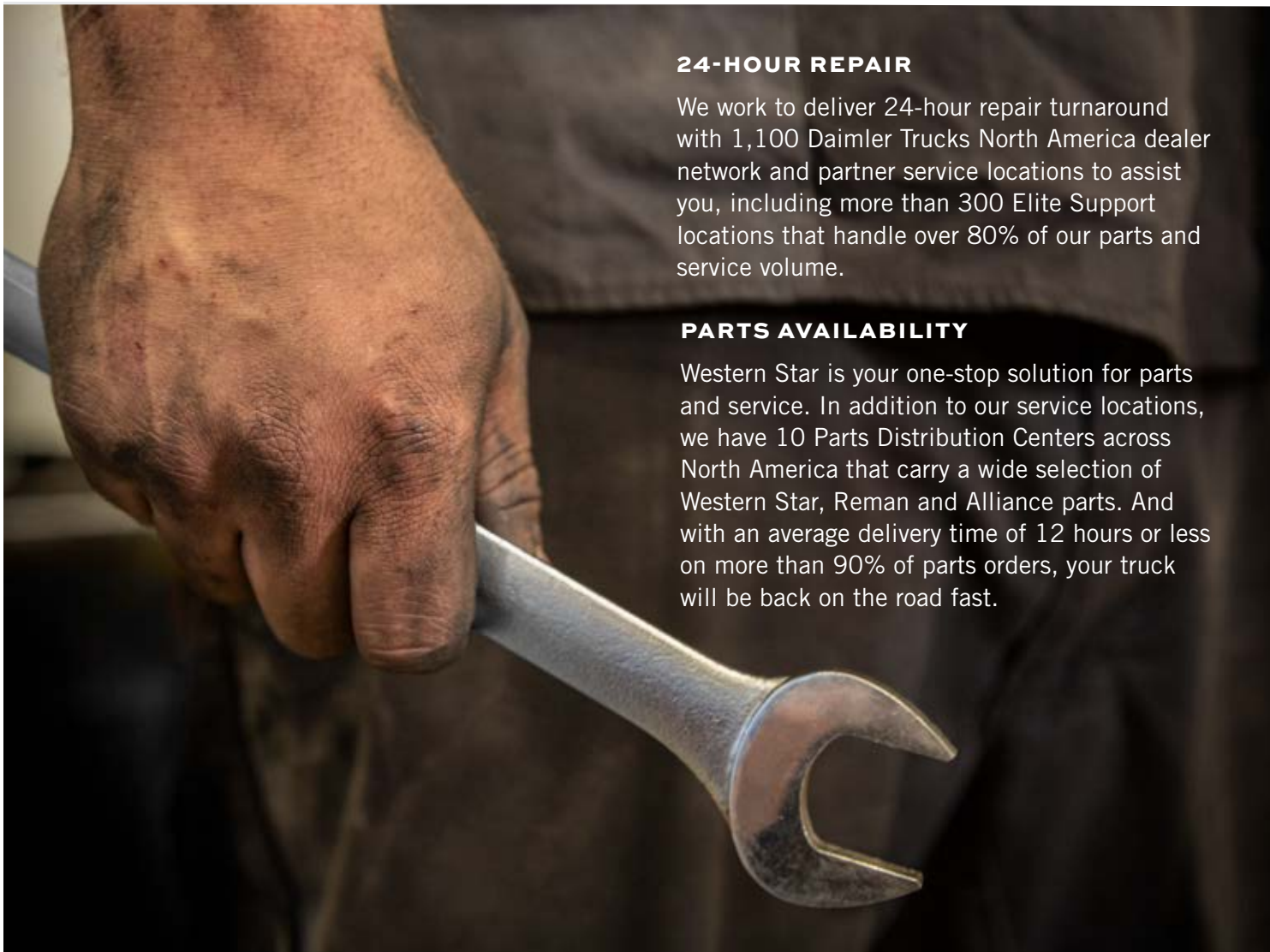

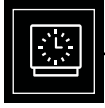

MAXIMIZED UPTIME

Detroit Connect®



PUT THE POWER

OF DATA TO WORK.

The 49X makes a big advancement in productivity with the Detroit Connect® suite of connected vehicle services, which translates vehicle performance data into real-time information you can use to keep your trucks on the jobsite and out of the shop.

DETROIT CONNECT VIRTUAL TECHNICIAN®

Standard on any Detroit® engine, Virtual Technician remote diagnostic service on the 49X helps increase uptime. If your truck experiences a fault, Virtual Technician sends you an alert, notifying you of the severity of the fault and how to fix it. Parts can even be ordered ahead of time, so your trucks spend less time in the shop. It's like having a team of experts from Detroit at your fingertips, working to keep your trucks on the job.

DETROIT CONNECT PORTAL

The Detroit Connect Portal gives you real-time truck data to make informed decisions about service, helping reduce downtime. This powerful tool offers a holistic view of your vehicle's fault codes and allows you to track fleet trends, giving you the power to plan for scheduled service.

LEARN MORE ABOUT
DETROIT CONNECT AT

DEMANDDETROIT.COM





FOR THE WESTERN STAR DEALER NEAREST YOU, CALL 866-850-7827
 WESTERNSTARTRUCKS.COM

**QUALITY BUILT
 IN THE USA**

DAIMLER | Western Star - A Daimler Group Brand

WS/MC-B-602. Specifications are subject to change without notice. Western Star Truck Sales, Inc. is registered to ISO 9001:2008 and ISO 14001:2004. Copyright © 2020 Daimler Trucks North America LLC. All rights reserved. Western Star Truck Sales, Inc. is a subsidiary of Daimler Trucks North America LLC, a Daimler company.

Cleveland, NC Portland, OR

